

VERSAFLOW 4 XL

A completely new dimension
of flexibility and variety



Ersa VERSAFLOW 4 XL

Think big! – Fit for future in selective soldering

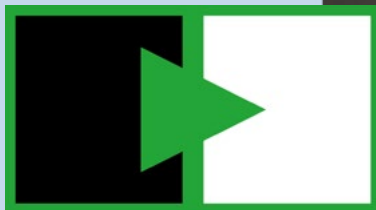

The Hermes Standard
for "M-to-M" in SMT Assembly



Highlights

- Max. PCB size 1,200 x 610 mm
- VERSAFLUX
- VERSAFLEX
- VERSACAM
- ERSASOFT 5
- CAD Assistant 4
- Automatic nozzle activation
- Additional stoppers to increase throughput

Parallel to miniaturization there is a trend towards very large, highly integrated components for use in control centers, for example. Another growth market is LED lighting technology. Printed circuit board formats of up to 610 x 1,200 mm can be soldered efficiently and safely with the VERSAFLOW 4 XL.

In the flux module, Ersa is setting new benchmarks in terms of flexibility and throughput with the VERSAFLUX. Here, up to four spraying heads can be installed on two completely independent axis systems. Application of the flux to the printed circuit board is monitored by laser – resulting in a safe automated process. In addition to the bottom heating with infrared emitters, a

top convection heater can also be configured for the preheating module of the VERSAFLOW 4 XL. This guarantees efficient, safe and homogeneous heating of the assemblies, even with the most complex of boards. There is an optional preheat module available upstream of the flux module for the VERSAFLOW 4 XL. This option allows the very gentle heating of heat-intensive assemblies to preheated final temperature after fluxing, protecting the flux from thermal decomposition.

With the VERSAFLEX module, the very latest Ersa technology is being used in the solder module. As with the VERSAFLUX, two independent axis systems work here so that both pots can solder in synchronous or asynchronous opera-

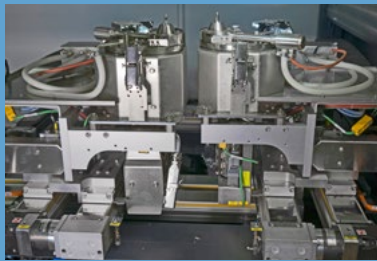

VERSAFLEX soldering module

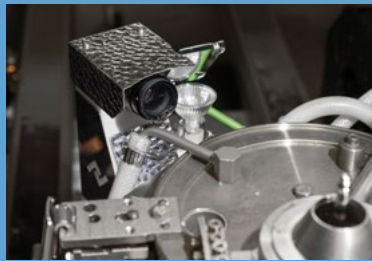

VERSACAM



CAD Assistant 4



Basic configuration

- Roller conveyor
- Side fixing in flux module
- ERSASOFT 5
- High-precision spray flux system with spray test function and flux level monitoring
- Bottom-side IR preheater
- Maximum PCB size 610 x 1,200 mm
- PC control with touch screen monitor
- Process visualization including solder protocol, process data writer, monitoring function, maintenance and error message indication, password protection
- Exhaust air monitoring
- Solder bath with electromagnetic solder pump
- Solder level- and solder wave height monitoring

tion. Up to two solder modules can be integrated in the VERSAFLOW 4 XL.

The VERSAFLOW 4 XL incorporates an interesting feature for the processing of smaller boards with a max. length of 330 mm. Thanks to an additional stopper in the flux, preheat and solder module, two assemblies can be processed simultaneously, thus doubling throughput. This does away with dual track conveyor systems. The complex machine movements are controlled using the intuitive operator software ERSASOFT 5. The modern and future-oriented CAD Assistant 4 is integrated in this software, which means complex programming of the solder parameters is a thing of the past.



Preheating

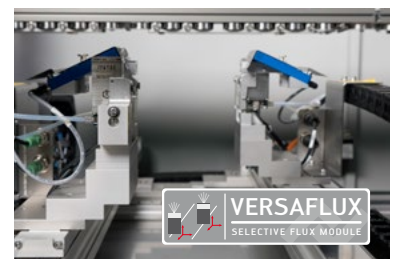

VERSAFLUX fluxing module



Automatic nozzle activation

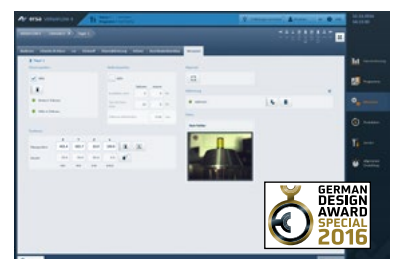

ERSASOFT 5



VERSAFLUX & VERSAFLEX

The new freedom for fluxing and soldering

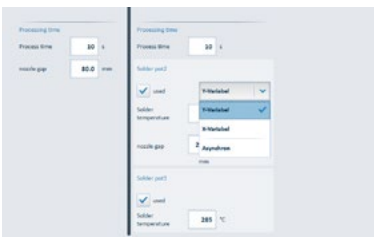

Highlights

- Simultaneous fluxing and soldering on PCB panels in x- or y-direction
- Highest flexibility coupled with shortest cycle time
- Automatic optimisation of cycle time through CAD Assistant 4
- VERSAFLEX: Double supply with the same or alternative flux

With the all-new VERSAFLEX and VERSAFLEX modules, Erska is setting benchmarks in quality, flexibility and throughput. As the name already suggests, VERSAFLEX is the flux module and VERSAFLEX is the solder module available in the new VERSAFLOW 4 XL.

Both modules work with two mutually independent axis systems, allowing the pots and spray heads to be adjusted and moved individually in x-, y- and z-direction. Assemblies can thus be fluxed or soldered synchronously or asynchronously. In synchronous mode, the two axes with the flux heads or pots move in parallel at a predetermined fixed distance to one another – ideal for panel processing. In asynchronous mode, each axis follows its own travel path. This means an assembly can be processed with

two different nozzle diameters at the same time, for example. Through this, and through operation with different solder alloys and/or fluxes without changeover necessary, they also create a tremendous added value for production an offer maximum flexibility.

The complex machine movements are controlled using the intuitive operator software ERSASOFT 5. This incorporates the future-oriented editor CAD Assistant 4 which the operator uses for the fast and simple creation and management of solder programs.

CAD Assistant 4

The future in soldering program creation

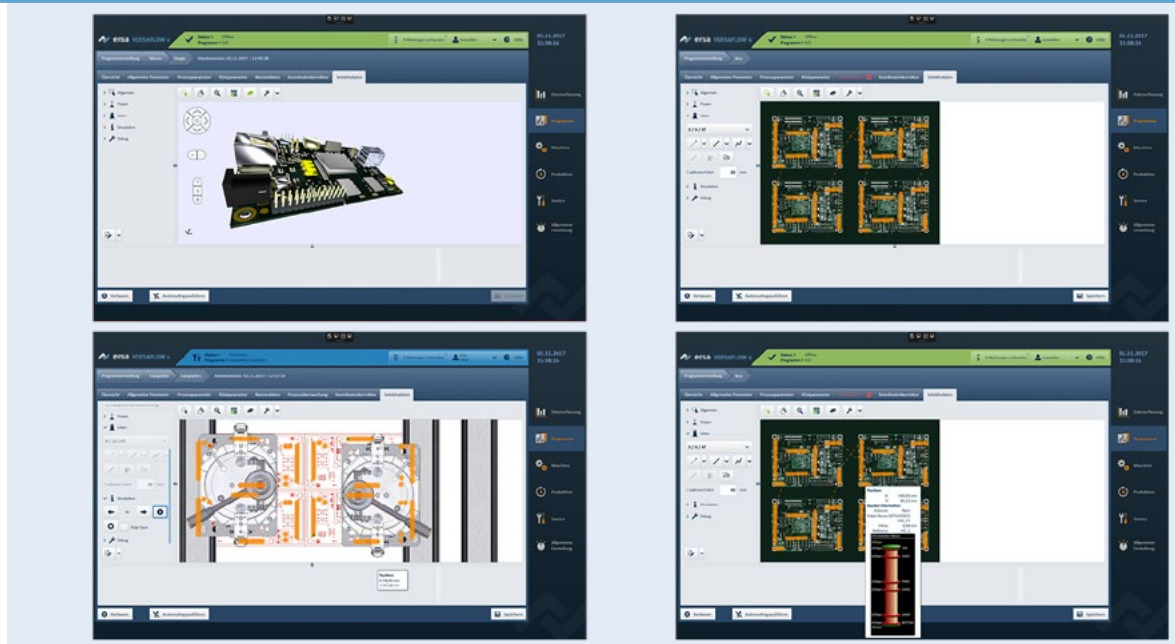

The efficient generation of complex solder programs is of great importance. The Ersas CAD Assistant 4 provides for an offline program generation while the machine is in operation! This ensures highest machine availability.

CAD Assistant 4 considers the specific equipment configuration in the generation of a solder program. Furthermore, it supports modules with two independent axes (VERSAFLUX & VERSAFLEX). The data sets of the CNC axes are processed using Drag&Drop. Furthermore, CAD Assistant 4 includes pre-defined data sets the user can easily adapt to his specific application. Errors during the program creation are prevented by a plausibility check. Both CAD files of PCBs and image files can be used as basis in the program generation with CAD Assistant 4.

All movements of the fluxer and the solder pots are graphically entered on the image of the board, after which the process data is added. Program files created with the CAD Assistant 4 can easily be verified by means of process simulations and can immediately be used in the selective soldering machine.

During programming the user selects the operating mode: x/z-variable or y/z-variable for synchronous processing of PCB panels or the asynchronous mode where the axes move independently in x-y-z. Due to the new auto-routing feature, the generation of complex solder programs is super easy: The user only enters the tracks or single joints to be fluxed and soldered. CAD Assistant 4 then automatically sets the machine movements in the most efficient way.

Highlights

- Intuitive programming due to graphic user interface
- Optimized cycle times by means of auto-routing
- Automatic and optimized assignment of fluxing and soldering jobs to the available modules
- Prevention of crashes by the definition of exclusion areas
- Program simulation to verify settings
- Support of modules with two independent axes (VERSAFLUX & VERSAFLEX)
- Management of up to 3 solder modules
- Simple scaling of the assembly
- File import of CAD formats: ODB++, IPC 2581, GenCAD
- File import of image formats: .jpg, .bmp, .png, .tif, .gif

The VERSAFLOW 4 XL concept

Highest throughput for every size of PCB

Large boards 680 x 610 mm



Small boards 330 x 610 mm

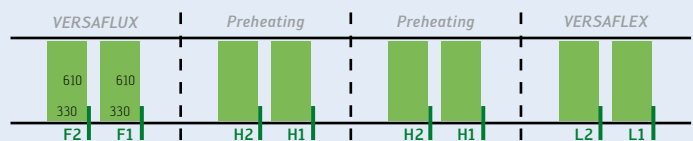

Long boards 1,200 x 610 mm

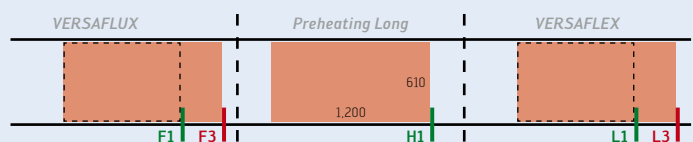
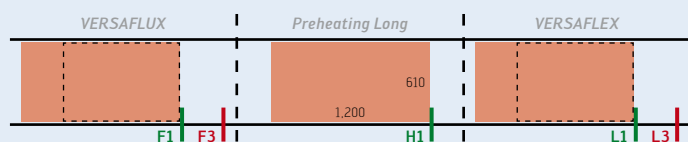

Recommendation for long boards 1,200 x 610 mm

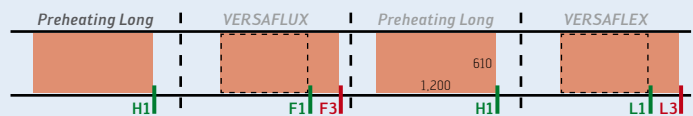
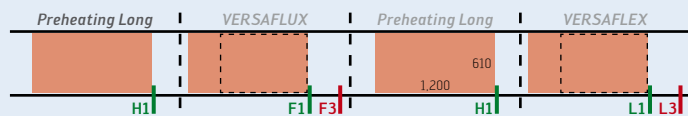

The VERSAFLOW 4 XL offers highest quality and throughput for every size of printed circuit board. The processing window is max. 680 x 610 mm in all modules. The trick used for processing printed circuit boards with a length of up to 1,200 mm: two stoppers. When the assembly stops at the first stopper, the front part is processed, at the second stopper the rear part.

The preheating module of the VERSAFLOW 4 XL comprises two heating modules with 680 x 610 mm controlled via the ERSASOFT 5 machine software. For assemblies longer than 680 mm, the two emitters are joined to form one large heating module. An

additional preheating module can be configured as an option upstream of the flux module for the processing of long, high-mass boards, so that the printed circuit board can be preheated evenly and gently there.

The VERSAFLOW 4 XL offers an interesting option for smaller assemblies up to a max. length of 330 mm. Thanks to an additional stopper in each module, two assemblies per module can be stopped in the transport system. With VERSAFLUX and VERSAFLEX, the two assemblies can be processed separately but simultaneously. This option doubles system throughput and does away with dual track conveyor systems. The tremen-

dous advantage of this is flexibility: the stoppers can be selected and deselected via software, which means a production mix between large printed circuit boards and small formats is no problem.

The Ersa Modular System

We optimize the soldering process for your specific needs

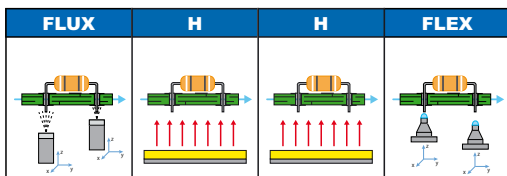

Configuration examples

The combinations shown here only illustrate a few of the almost infinite number of combination options offered by the highly flexible Ersa Modular System.

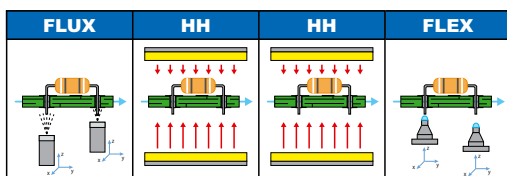

Depending on customer wishes, throughput of smaller printed circuit boards can be significantly increased by the use of dual pot modules or additional stoppers without increasing the module footprint

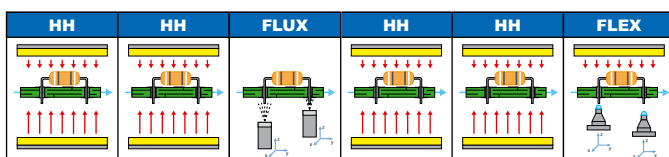
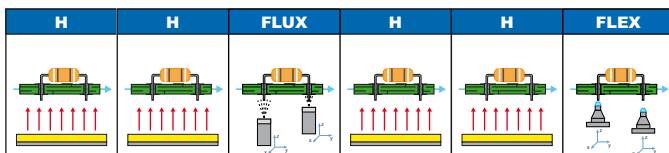

Legend:

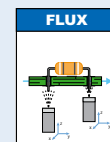

VERSAFLUX flux module

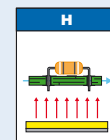

Preheat module with bottom-side heating

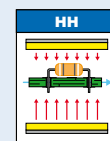

Preheat module with top-side and bottom-side heating

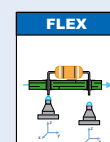

VERSAFLEX solder module

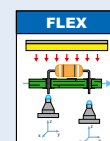

VERSAFLEX solder module with top-side heating



Technical data VERSAFLOW 4 XL

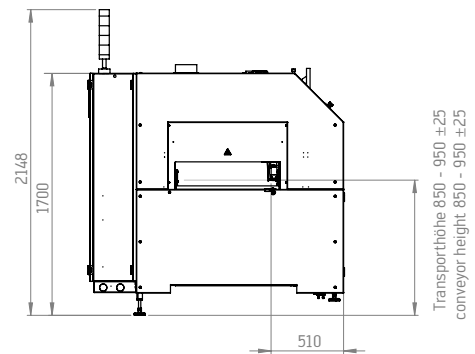
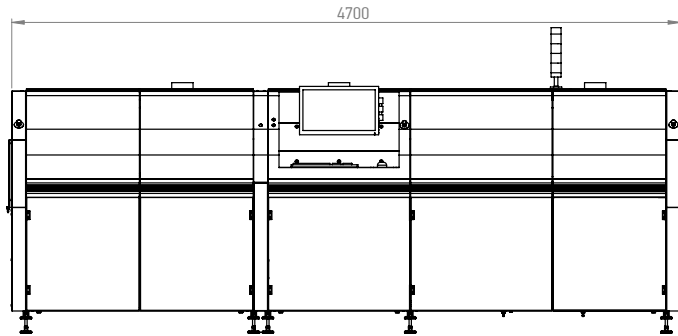

VERSAFLOW 4 XL (basic system)	
Length:	4,700 mm
Width:	1,800 mm
Height:	1,600 mm
Weight:	2,500 kg
Type:	inline
PCB loading:	manual/automatic

Electrical data	
Power:	5-wire system, 3 x 230/400 V, N, PE
Power tolerance range:	±5 %
Frequency:	50/60 Hz
Power consumption:	22 kW
Safety fuse:	3 x 125 A

Conveyor system	
Type:	roller conveyor
PCB width:	50 – 610 mm (single track)
PCB length:	127 – 680 (1,200 mm option)
Clearance from PCB edge:	3 mm
PCB top side clearance:	max. 120 mm
PCB bottom side clearance:	max. 60 mm
Speed:	0.2 – 15 m/min
Mask/PCB weight:	8 kg (heavy load conveyor optional) (15 kg)

Flux module	
Type:	high-precision spray fluxer
Positioning system:	2 axis, servo motor driven
Flux storage tank:	1.8 l
Positioning speed:	1 – 400 mm/s
Fluxer speed:	20 mm/s
Positioning accuracy:	±0.15 mm
Spray width:	2 – 8 mm (130 µm nozzle)

Preheat module	
Type:	IR bottom-side (basis), top-side convection (option)
Power:	12 kW per IR heater
Temperature:	200 °C

Miniwave solder module	
Solder wave height:	max. 5 mm
Clearance from PCB edge:	min. 3 mm
Solder volume:	approx. 14 kg (Sn63Pb) approx. 13 kg (lead-free)
Solder temperature:	max. 330 °C
Warm-up time:	75 min to 280 °C
Positioning speed:	X/Y; 2 – 200 mm/s
Soldering speed:	10 mm/s
Positioning accuracy:	±0.15 mm

Nitrogen technology	
Nitrogen supply:	to be supplied locally
Nitrogen injection:	N ₂ cover over the solder bath
Required pressure:	6 bar
Consumption:	approx. 1.5 m ³ /h per pot
Particle cleanliness:	5.0 (recommendation)

Compressed air	
Compressed air supply:	to be supplied locally
Required pressure:	6 bar
Consumption :	< 5 m ³ /h

Exhaust rating	
Exhaust stacks:	2 pc., OD 150 mm
Exhaust volume per stack:	300 m ³ /h

Environmental specs/noise level	
Ambient temperature:	15 – 35 °C
Permanent sound level:	<65 dB(A)

America
Ersa North America
info-ena@kurtzera.com

Mexico
Kurtz Ersa, S.A. de C.V.
info-kmx@kurtzera.com

Asia
Kurtz Ersa Asia Ltd.
info-eap@kurtzera.com

China
Ersa Shanghai
info-esh@kurtzera.com

France
Ersa France
info-efr@kurtzera.com

Ersa GmbH | Leonhard-Karl-Str. 24
97877 Wertheim/Germany

Tel. +49 9342 800-0
info@ersa.de | www.ersa.com

 **kurtz ersa**