

Ersa POWERFLOW PRO

Cost-optimized wave soldering
in a nitrogen atmosphere



Ersa POWERFLOW PRO

Cost-optimized wave soldering in a nitrogen atmosphere



Highlights

- Spray fluxer with intelligent spray pattern programming
- Modular, flexible and individually expandable preheating concept with convection heating and emitters; variable configuration in length and performance (also possible at a later date)
- ERSASOFT 5 operating software on databank basis
- Long wetting times
- Extremely stable solder wave height
- Nozzle combinations for every requirement
- Concepts for optional exchange solder pots
- Automatic production with code operation possible
- Ready for Industry 4.0

Based on absolutely stable processes and reproducible parameters, the high-performance Ersa wave soldering systems ensure the customer top standards when it comes to quality, costs and delivery service.

The POWERFLOW PRO from the Ersa POWERFLOW series is a high-performance, technically state-of-the-art full nitrogen tunnel system with an attractive price-performance ratio

Fluxer

Ersa spray fluxers offer numerous innovative solutions with regard to flux consumption and processing speed, ensuring extremely safe and economical processes. For example, spray patterns can be entered

graphically for each product in the ERSASOFT machine software, which greatly reduces flux consumption.

Preheating

In addition to medium- and short-wave infrared emitters, convection heaters are also available in the modular POWERFLOW PRO. The IR emitters react immediately and are therefore ideal for mixed production. Convection modules are perfect with large, high-mass components or with temperature-sensitive components that must not be overheated. Thanks to the individually configurable and modularly expandable preheating

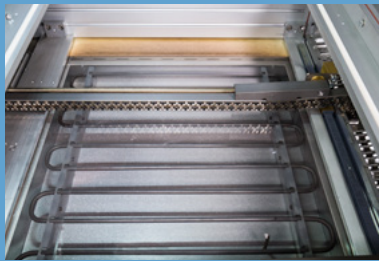

Medium wave emitter

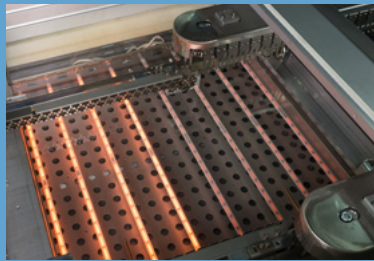

Short-wave emitter

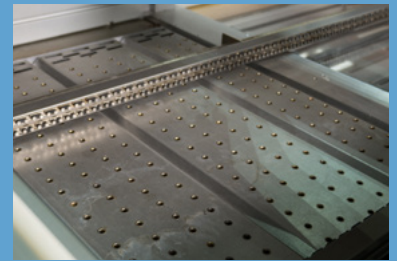

Convection preheating

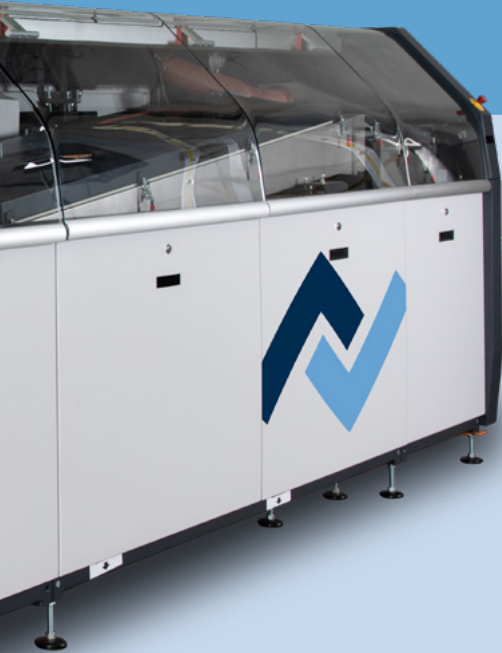

Basic configuration

- Integrated, complete lead-free capability and reliability when using VOC-free, water-based flux
- Full nitrogen tunnel system
- Precise spray fluxer with motorized axis drive and 10 l flux tank
- Frame conveyor with a working width of 330 or 400 mm, respectively finger conveyor with a working width of 458 mm
- 1,500 or 2,000 mm preheating length
- Intermediate heating
- Award-winning ERSASOFT 5: simple and intuitive operation

concept, the POWERFLOW PRO can be individually adapted to the respective product requirements.

Solder module

The POWERFLOW PRO works with the proven Ersas double wave soldering technology. Its solder module was completely re-engineered on this basis. Thanks to various combinations of solder nozzles the user-friendly solder aggregate can be optimally adapted to the respective application. Besides long wetting times, high wave heights are possible.

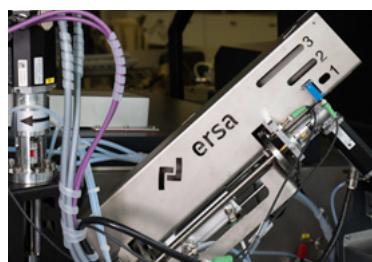

Solder bar feeder



Nitrogen control

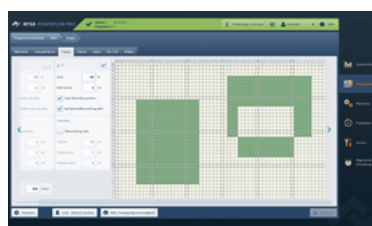

Fluxer for sequential fluxing



Innovative ERSASOFT 5

Technical data Ersa POWERFLOW

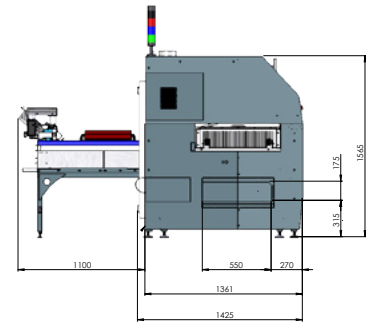
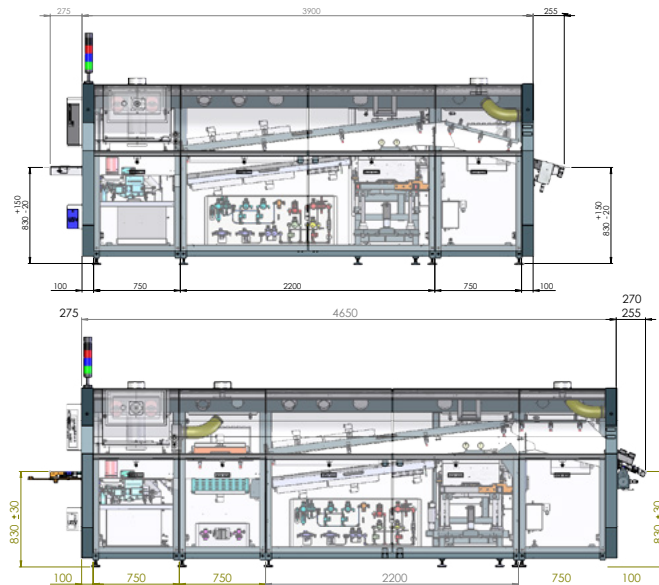

Dimensions	
Length:	3 preheating modules 3,900 mm 4 preheating modules 4,650 mm
Width:	1,425 mm
Height:	1,580 mm
Weight:	3 preheating modules 2,200 kg 4 preheating modules 3,000 kg
Paint:	RAL 7035 / 7016

Pneumatic system	
Inlet pressure:	min. 6 bar
Air consumption:	approx. 5 – 10 m ³ /h

Extraction	
Exhaust connections	1x 800 m ³ /h and 2x 200 m ³ /h

Environmental specifications	
Ambient temperature:	10 – 35 °C
Humidity:	20 – 95 % (non condensating)

Noise level	
Permanent noise level:	< 65 dB (A)

Conveyor system	
Type:	frame conveyor, finger-type conveyor
Conveyor width	
Frame conveyor	330/400 mm
Finger-type conveyor:	60 – 458 mm
PCB length:	120 – 500 mm
PCB top-side clearance:	max. 100 mm
Conveyor speed:	0.5 – 2.5 m/min
Conveyor angle:	7° (fixed angle)

Electrical data	
Voltage:	5-wire system, 3x 230/400 V, N, PE
Voltage tolerance:	±10 %
Frequency:	50/60 Hz
Fuse rating:	3x 80 A (slow blow)
Amperage:	74 A
Capacity:	46 kW

Flux module	
Flux storage tank:	10 l
Spray pressure:	0.9 – 2.5 bar
Type:	Pneumatic system

Bottom-side preheat module	
Type:	dynamic short-wave emitter
Capacity:	max. 7.8 kW (power controlled)
Type:	medim-wave emitter
Capacity:	max. 4 kW (controlled)
Type:	convection module
Capacity:	max. 4 kW (controlled)
Dimensions:	500 mm length each

Solder module	
Capacity:	approx. 9.2 kW
Solder volume:	approx. 525 kg (lead-free) approx. 630 kg (Sn63Pb37)
Warm-up time:	approx. 3.5 h
Solder temperature:	max. 300 °C
Solder bar feeder:	automatic

America
Kurtz Ersä, Inc.
usa@kurtzersa.com

Mexico
Kurtz Ersä, S.A. de C.V.
info-kmx@kurtzersa.com

Asia
Kurtz Ersä Asia Ltd.
asia@kurtzersa.com

China
Ersä Shanghai
info-esh@kurtzersa.com

France
Ersä France
info-efr@kurtzersa.com

Ersä GmbH | Leonhard-Karl-Str. 24
97877 Wertheim/Germany

Tel. +49 9342 800-0
info@ersa.de | www.ersa.com

 **kurtz ersä**